

CV

Circular electric duct heaters

CV

Circular electric duct heaters

VEAB circular electric duct heaters are used for heating the ventilation air supplied to individual rooms and zones, with individually controlled temperatures. In correctly designed systems, they can also heat the entire building. Circular electric duct heaters are also used for preheating or reheating for ventilation units. The duct heaters are available with built-in electronic regulator or for external control. An electronic flow monitor is also available, if required.

- 8 sizes: 80 - 400 mm dia.
- Output range 200 W – 12000 W
- Tightness class C to EN 1751
- A built-in electronic flow monitor is included in several of the models
- With built-in regulator or for external control
- Two built-in overheating protections
- Enclosed stainless steel plain-tube elements

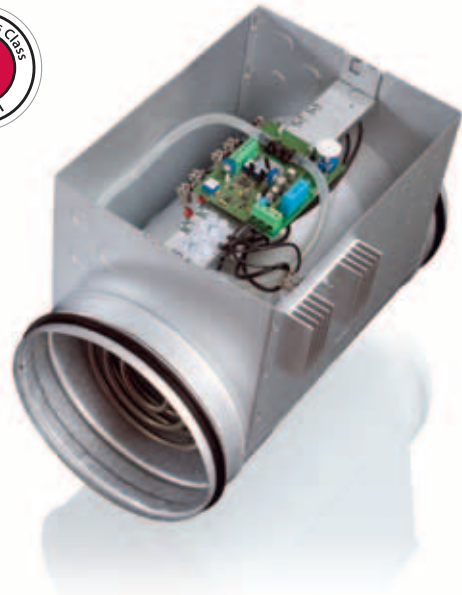

Standard design

The casing is made of Aluzinc-coated sheet steel and the heater elements are made of stainless steel to EN 1.4301. The junction box includes the necessary terminal blocks for the electrical connections. The duct connection is suitable for insertion mounting in circular ducts. The CV is produced to degree of protection IP43, but is also available to IP55 to special order (not the -MQU, -MTU and -PTU versions).

Overheating protection

All CV heaters have two overheating protections, one of which is with automatic reset and the other with manual reset. On delivery, these are connected in series with the heater elements and therefore need not be connected to an external relay (not the -E version; see page 13). This improves reliability and lowers the installation costs.

All duct heaters (not the -R version; see page 13) have the overheating protection reset on the heater cover.

Air velocity

The duct heaters are designed for a minimum air velocity of 1,5 m/s. Some versions though, are designed for a air velocity down to 0,5 m/s. See page 14-15.

Air tightness class C

The CV duct heater conforms to air tightness class C, which ensures that the heated air will reach its destination and will not leak out of the ventilation system – which saves energy and money.

Electronic flow monitor

All models with built-in control, and designed for air velocity down to 1,5 m/s, can also be supplied with a built-in electronic flow monitor. The flow monitor continually monitors the air flow and shuts down the heater if the air velocity should drop below 1.5 m/s, thus avoiding overheating. When the air velocity again exceeds 1.5 m/s, the heater will automatically be switched on. This means that the CV with built-in flow monitor meets the requirements for interlocking with the fan/air flow and can be installed without any external interlocking. This ensures very simple installation.

Alarm relay, designation suffix -L

All models can be equipped with a built-in relay with potential-free alarm contacts that indicate loss of power supply or tripping of the manually resettable overheating-protection. The alarm relay is included as standard in models -MQXL and -MTXL.

Approvals

The duct heaters have been tested and approved by SEMKO in accordance with:

LVD Directive: EN 60355-1, EN 60335-2-30, SEMKO 111-1967 mod 1-4 and SEMKO 111 FA1982.

EMC Directive: EN 50081-1, EN-50082-1, EN 61000-3-2 and EN 61000-3-3

EMF Directive: EN 50366



Control

Built-in regulator

A built-in regulator ensures simple installation, e.g. due to fewer cable runs, which lowers the installation cost and reduces the risk of incorrect wiring. The regulator is electronic and controls the output across a triac by means of time proportional control (intermittent ON/OFF control). This provides very accurate temperature control. Since control is electronic, it is entirely silent and sustains a minimum of wear.

The following models are available with built-in regulator:

-MQU(L) and -MTU(L), for one sensor

Duct heater with built-in temperature regulator for room or duct sensor. The setpoint can be set on the heater cover or externally. See page 6.

-MQEM(L) and -MTEM(L), for two sensors

Duct heater with built-in temperature controller for external room sensor with setpoint adjuster. The minimum and maximum supply air temperatures are set on the duct heater circuit board. See page 8.

-MQXL and -MTXL, for 0...10V control signal

Duct heater with built-in regulator for external 0...10V control signal. See page 10.

External regulator

Our duct heaters can also be delivered without built-in regulator, and an external regulator must then be added. The following models are available for external regulator:

-M(L), -E(L) and -R(L)

An external temperature regulator and sensor must be provided for the duct heater. See pages 12 and 13.

Air velocity down to 0,5 m/s

-PTU(L), -PTEM(L), -PTXL, -P(L)

See page 14-15.

Options other than the standard version

In addition to the standard design, several options are available for matching to your specific application.

Other materials

The casing can be made of stainless steel, EN 1.4301, or of stainless acid-proof steel, EN 1.4404.

Anti-condensation insulation (not CV Ø100 och Ø125)

In order to reduce the risk of condensation in the junction box if the duct heater is installed in a warm and humid area and the air in the duct is cold, the inside of the junction box is provided with additional 4 mm thick insulation.

Degree of protection IP55

To special order, the duct heaters can be made to degree of protection IP55 instead of the standard IP43 version (not -MQU and -MTU).

Duct heater with an outlet temperature higher than 50°C

Available only in a rectangular version with circular connection. See "Rectangular electric duct heaters".

Sizes larger than 400 mm

Available only in a rectangular version with circular connection. See "Rectangular electric duct heaters".

Outputs higher than 12 kW

Available only in a rectangular version with circular connection. See "Rectangular electric duct heaters".

Strengthened electrical insulation

Available only in a rectangular version with circular connection. See "Rectangular electric duct heaters".

Overview of range

| Size designation | | CV 10 | CV 12 | CV 16 | CV 20 | CV 25 | CV 31 | CV 40 |
|--|---------|----------------|-----------------|-----------------|----------------|-----------------|----------------|----------------|
| Diameter (Ø mm) | | 100 | 125 | 160* | 200 | 250 | 315 | 400** |
| Minimum air flow rate, m ³ /h | | 43 | 70 | 110 | 170 | 270 | 415 | 690 |
| Rating | Voltage | | | | | | | |
| 300 W | 230V~ | | X ³ | X ² | | | | |
| 400 W | 230V~ | X ³ | | | | | | |
| 600 W | 230V~ | X ³ | X ⁵ | X ³ | X ² | X ¹ | | |
| 900 W | 230V~ | | X ⁷ | X ⁴ | X ² | X ² | X ¹ | |
| 1200 W | 230V~ | | X ⁸ | X ⁵ | X ³ | X ² | X ¹ | |
| 1500 W | 230V~ | | X ⁹ | X ⁶ | X ³ | X ³ | X ² | |
| 1800 W | 230V~ | | X ¹⁰ | X ⁶ | X ⁴ | X ³ | X ² | |
| 2100 W | 230V~ | | | X ⁷ | X ⁴ | X ³ | X ² | |
| 2700 W | 230V~ | | | X ⁸ | | | | |
| 3000 W | 230V~ | | | | X ⁶ | X ⁴ | X ³ | X ² |
| 3000 W | 400V2~ | | | | X ⁶ | X ⁴ | X ³ | X ² |
| 3300 W | 400V2~ | | | X ⁹ | | | | |
| 5000 W | 400V2~ | | | X ¹² | X ⁸ | X ⁶ | X ⁴ | X ³ |
| 6000 W | 400V2~ | | | | X ⁹ | X ⁷ | X ⁴ | X ³ |
| 5000 W | 400V3~ | | | X ¹² | | | | |
| 6000 W | 400V3~ | | | | X ⁹ | X ⁷ | X ⁴ | X ³ |
| 9000 W | 400V3~ | | | | | X ⁹ | X ⁶ | X ⁴ |
| 12000 W | 400V3~ | | | | | X ¹⁰ | X ⁷ | X ⁵ |

*= Also available with 150 mm dia. Delivered without rubber seals
 **=Also available with 355 mm dia. Delivered without rubber seals.

- 1= See pressure drop curve 1
- 2= See pressure drop curve 2
- 3= See pressure drop curve 3
- 4= See pressure drop curve 4
- 5= See pressure drop curve 5
- 6= See pressure drop curve 6
- 7= See pressure drop curve 7
- 8= See pressure drop curve 8
- 9= See pressure drop curve 9
- 10= See pressure drop curve 10
- 11= See pressure drop curve 11
- 12= See pressure drop curve 12

Pressure drop graph

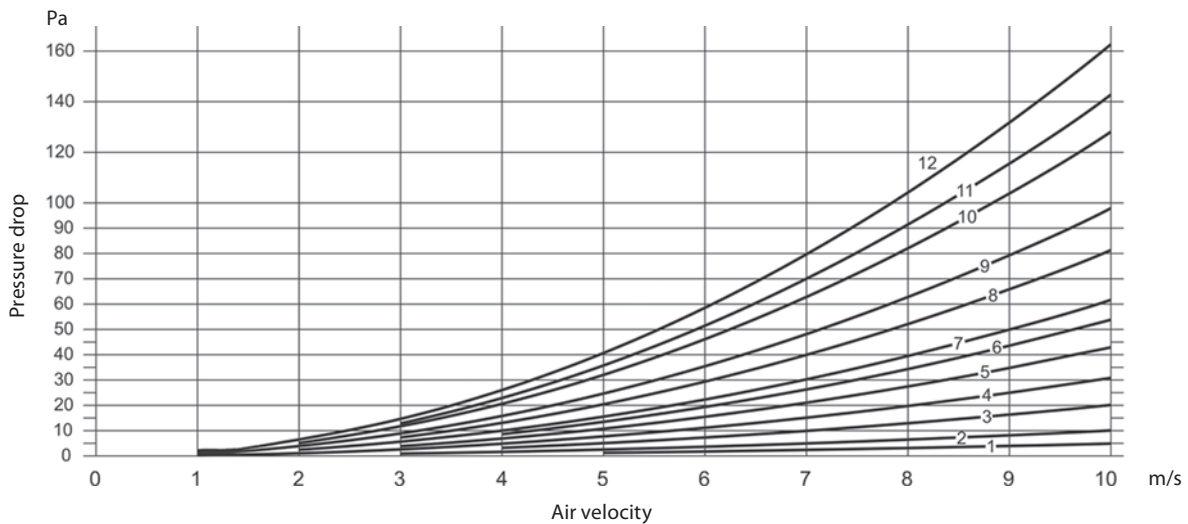

Installation

The duct heaters can be installed in either a horizontal or a vertical duct. The air must flow through the duct heater in the direction of the arrow shown on the duct heater. In a horizontal duct, the junction box may face either upwards or at 90° to either side. Installation with the junction box at the bottom is not permissible. The distance to or from a duct bend, fan, damper or the like must be at least twice the connection diameter.

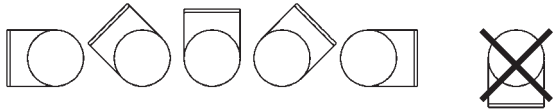

Interlock with fan/air flow rate

Electric duct heaters must always be installed so that they are interlocked either with the fan that delivers the air into the duct or with the air flow rate through the heater. The power supply to the duct heater must be isolated if the fan/air flow is switched off.

The -MQU, -MQEM and -MQXL models with built-in electronic flow monitor conform to the requirement for interlocking with the fan/air flow rate and can be installed without external interlocking.

For other models, this function must be connected on the incoming power supply to the duct heater or, if the heater has a built-in regulator, directly to the regulator.

Minimum air velocity and outlet air temperature

The duct heaters are designed for a minimum air velocity of 1.5 m/s and a maximum operating outlet air temperature of 50°C (for higher temperatures, see “Rectangular electric duct heaters”).

Ambient air temperatures for duct heaters:
 Without built-in control equipment = 40°C max.
 With built-in control equipment = 30°C max.

The following formula can be used for calculating the air velocity:

$$V = \frac{Q}{3600 \times A}$$

V = air velocity, m/s
 Q = air flow rate, m³/h
 A = cross-section area of duct heater, m²

$$A = \frac{\pi \times D^2}{4}$$

D = diameter of duct heater, Ø m

Power demand

The air flowing through the duct heater is heated in accordance with the following formula:

$$P = Q \times 0.36 \times \Delta t$$

P = rating in W
 Q = air flow rate in m³/h
 Δt = temperature rise in °C

Dimensions in mm

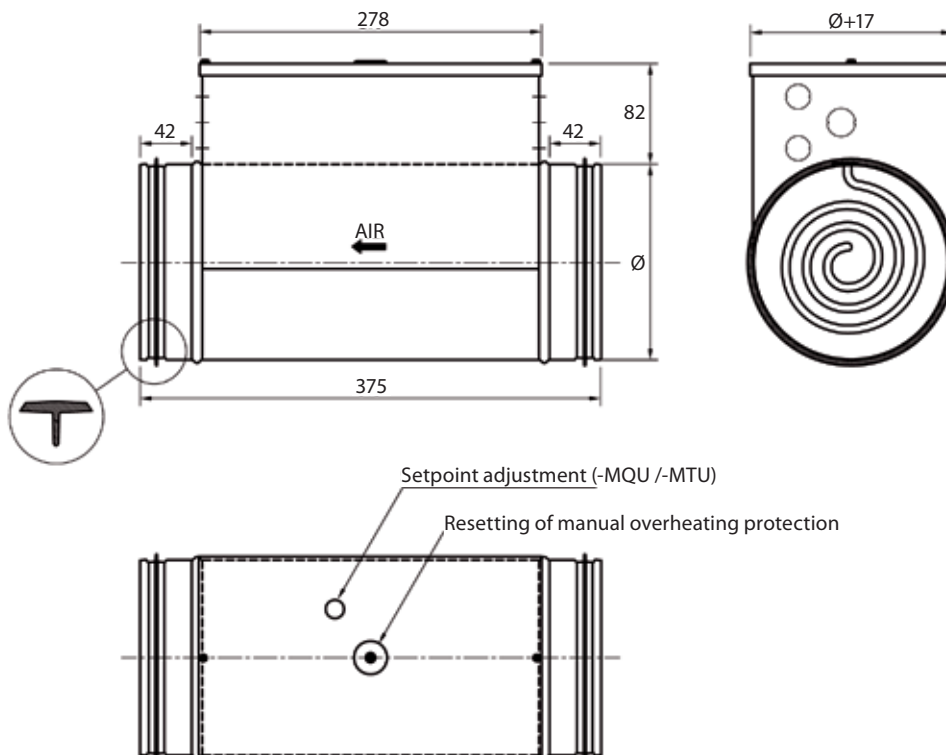

CV

Circular electric duct heater with built-in control equipment for a room or a duct sensor

The built-in control unit simplifies installation, e.g. by fewer cable runs. This, in turn, lowers the installation cost and reduces the risk of incorrect wiring.

The duct heater operates with an external room or duct sensor. The temperature is set on the heater cover or on an external setpoint adjuster.

- MQU

Duct heater with built-in temperature regulator for room or duct sensor. The heater can be reset for external setpoint adjustment or for setpoint adjustment on the heater cover. The -MQU model also has a built-in electronic flow monitor which simplifies the installation since it can be installed "stand alone".

The sensor and the setpoint adjuster are available as separate accessories.

- MTU

Same model as above but without built-in electronic flow monitor.

- MQUL and -MTUL

Same models as above but with built-in relay with potential-free alarm contacts that indicate loss of power supply or tripping of the manually resettable overheating protection.



Project design/ordering

Descriptive text for – MQU

VEAB type CV –MQU duct heater with casing of Aluzinc-coated sheet steel and stainless steel heater element to EN 1.4301. The duct heaters conform to air tightness class C to EN 1751. Built-in electronic flow monitor. Control takes place by a built-in temperature regulator for room or duct sensor. Setpoint adjustment takes place externally or on the heater cover. The sensor and any external setpoint adjuster must be ordered separately.

Descriptive text for – MTU

VEAB type CV –MTU duct heater with casing of Aluzinc-coated sheet steel and stainless steel heater element to EN 1.4301. The duct heaters conform to air tightness class C to EN 1751. Control takes place by a built-in controller for room or duct sensor. Setpoint adjustment is carried out externally or on the heater cover. The sensor and any external setpoint adjuster must be ordered separately.

Type designation

(example)

Size designation, see page 4

Rating in watt x 100

Voltage 1=230V~ 2=400V2~ 3=400V3~

Type of control (-MQU/-MQUL/-MTU/ MTUL, see above)

CV 16 - 50 - 2 MQUL

Accessories

There are several sensor/setpoint combinations for the CV -MQU(L)/-MTU(L). Five typical cases are presented here. For particulars of sensors, see page 17. For a complete wiring diagram, see the fitting instructions at our homepage www.veab.com (select Products/Duct heaters - Electric).

Duct sensor

Alt 1 Duct sensor with setpoint adjustment on the duct heater cover.



TG-K330 as duct sensor.



The setpoint is adjusted manually on the duct heater cover.

Alt 2 Duct sensor with external setpoint adjustment.



TG-K330 as duct sensor.



TG-R430 as setpoint adjuster.

Room sensor

Alt 3 Room sensor with setpoint adjustment.



TG-R430 both as setpoint adjuster and room sensor.

Alt 4 Room sensor with external setpoint adjustment.



TG-R530 (IP30) or TG-R630 (IP54) as room sensor.



TG-R430 as setpoint adjuster.

Alt 5 Room sensor with setpoint adjustment on the duct heater cover.



TG-R530 (IP30) or TG-R630 (IP54) as room sensor.



The setpoint is adjusted manually on the duct heater cover.

CV

Circular electric duct heater with built-in control equipment for two sensors – one room sensor and one min/max supply air sensor

The built-in control unit simplifies installation, e.g. by fewer cable runs. This, in turn, lowers the installation cost and reduces the risk of incorrect wiring. The duct heater operates with an external room or duct sensor. The temperature is set on an external setpoint adjuster.

- MQEM

Duct heater with built-in control equipment for room sensor with setpoint adjuster type TG-R430 and supply air sensor TG-K360. The required room air temperature is set on the TG-R430. The minimum and maximum supply air temperatures are set on the duct heater circuit board. The -MQEM model also has a built-in electronic flow monitor which simplifies the installation since it can be installed “stand alone”. The sensor and the nearest setpoint adjuster are available as separate accessories.

- MTEM

Same model as above but without built-in electronic flow monitor.

- MQEML and -MTEML

Same models as above but with built-in relay with potential-free alarm contacts that indicate loss of power supply or tripping of the manually resettable overheating protection.



Project design/ordering

Descriptive text for – MQEM

VEAB type CV –MQEM duct heater with casing of Aluzinc-coated sheet steel and stainless steel heater element to EN 1.4301. The duct heaters conform to air tightness class C to EN 1751. Built-in electronic flow monitor. Control takes place by built-in temperature regulator for room sensor with setpoint adjuster and separate supply air sensor. The sensor and external setpoint adjuster must be ordered separately.

Descriptive text for – MTEM

VEAB type CV –MTEM duct heater with casing of Aluzinc-coated sheet steel and heater element of stainless steel to EN 1.4301. The duct heaters conform to air tightness class C to EN 1751. Control takes place by built-in temperature regulator for room sensor with setpoint adjuster and separate supply air sensor. The sensor and external setpoint adjuster must be ordered separately.

Type designation

(example)

Size designation, see page 4

Rating in watt x 100

Voltage 1=230V~ 2=400V2~ 3=400V3~

Type of control (-MQEM/-MQEML/-MTEM/ MTEML; see above)

CV 16 - 50 - 2 MQEML

Accessories

There are several sensor/setpoint combinations for the CV -MQEM(L)/-MTEM(L). Three typical cases are presented here. For particulars of sensors, see page 17. For a complete wiring diagram, see the fitting instructions at our homepage www.veab.com (select Products/Duct heaters - Electric).

Room sensor

Alt 1 Room sensor with setpoint adjustment.



TG-R430 as both setpoint adjuster and room sensor.



TG-K360 duct sensor for min/max supply air temperature.

Alt 2 Room sensor and separate setpoint adjustment.



TG-R530 (IP30) or TG-R630 (IP54) as room sensor.



TG-R430 as setpoint adjuster.



TG-K360 duct sensor for min/max supply air temperature.

Duct sensor

Alt 3 Duct sensor with external setpoint adjustment.



TG-K330 duct sensor as exhaust air sensor.



TG-R430 as setpoint adjuster.



TG-K360 duct sensor for min/max supply air temperature.

CV

Circular electric duct heater with built-in control equipment for external 0...10V control signal

The built-in control unit simplifies installation, e.g. by fewer cable runs. This, in turn, lowers the installation cost and reduces the risk of incorrect wiring.

- MQXL

Duct heater with built-in control equipment for 0...10V control signal.

The -MQXL model also has a built-in electronic flow monitor which simplifies the installation since it can be installed “stand alone”.

The heater has a built-in relay with potential-free alarm contacts that indicate loss of power supply or tripping of the manually resettable overheating protection.

- MTXL

Same model as above but without built-in electronic flow monitor.



Project design/ordering

Descriptive text for – MQXL

VEAB type CV –MQXL duct heater with casing of Aluzinc-coated sheet steel and stainless steel heater element to EN 1.4301. The duct heaters conform to air tightness class C to EN 1751. Built-in electronic flow monitor and built-in relay with potential-free alarm contacts that indicate loss of power supply or tripping of the manually resettable overheating protection. Control takes place by a built-in regulator for external 0...10V control signal.

Descriptive text for –MTXL

VEAB type CV –MTXL duct heater with casing of Aluzinc-coated sheet steel and stainless steel heater element to EN 1.4301. The duct heaters conform to air tightness class C to EN 1751. Built-in relay with potential-free alarm contacts that indicate loss of power supply or tripping of the manually resettable overheating protection. Control takes place by a built-in regulator for external 0...10V control signal.

Type designation

(example)

Size designation, see page 4

Rating in watt x 100

Voltage 1=230V~ 2=400V2~ 3=400V3~

Type of control (-MQXL/-MTXL; see above)

CV 16 - 50 - 2 MQXL

Control with accessories

There are several ways of controlling a CV -MQXL/-MTXL. Three examples are presented here.
For a complete wiring diagram, see the fitting instructions at our homepage www.veab.com
(select Products/Duct heaters - Electric).

Master system

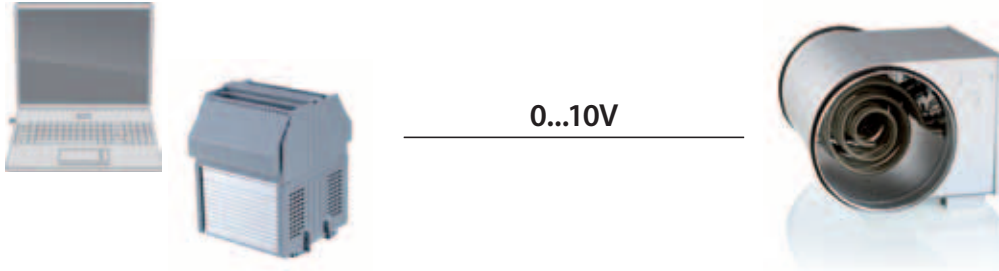

Ventilation unit that has built-in control with a 0...10V output for a reheater coil

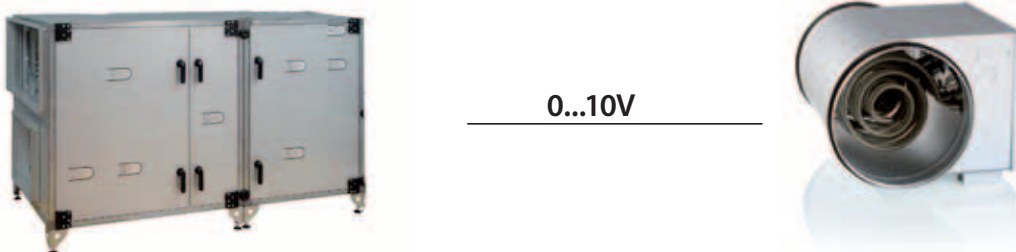

0...10V regulator control

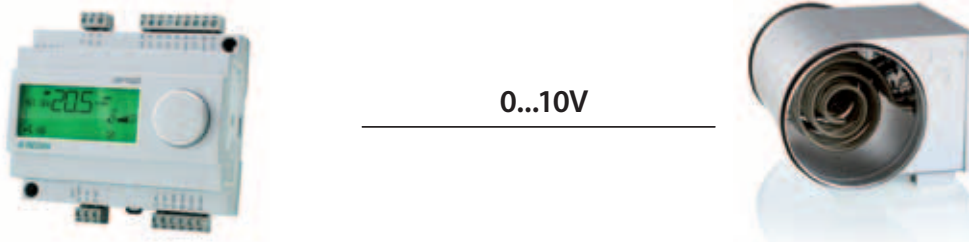

CV

Circular electric duct heater for external control equipment

VEAB electric duct heaters for external control must be equipped with an external temperature regulator. These can be mounted on a wall or in an equipment cubicle. Regulators and sensors must be ordered separately (see pages 16 and 17).

- M

Suitable control by PULSER or TTC type regulator.
The overheating protection is reset manually on the duct heater cover.
Ratings up to and including 9000 W.

- ML

Same model as above but with built-in relay with potential-free alarm contacts that indicate loss of power supply or tripping of the manually resettable overheating protection.



Project design/ordering

Descriptive text for – M

VEAB type CV –M duct heater with casing of Aluzinc-coated sheet steel and stainless steel heater element to EN 1.4301. The duct heaters conform to air tightness class C to EN 1751. Control takes place by an external regulator and sensor that must be ordered separately.

Descriptive text for – ML

VEAB type CV –ML duct heater with casing of Aluzinc-coated sheet steel and stainless steel heater element to EN 1.4301. The duct heaters conform to air tightness class C to EN 1751. Built-in relay with potential-free alarm contacts that indicate loss of power supply or tripping of the manually resettable overheating protection. Control takes place by an external regulator and sensor that must be ordered separately.

Type designation

(example)

Size designation, see page 4

Rating in watt x 100

Voltage 1=230V~ 2=400V2~ 3=400V3~

Type of control (-M/-ML; see above)

CV 16 - 50 - 2 ML

CV

Circular electric duct heater for external control equipment

VEAB electric duct heaters for external control must be equipped with an external temperature regulator. These can be mounted on a wall or in an equipment cubicle. Regulators and sensors must be ordered separately (see pages 16 and 17).

- R

The built-in manual overheating protection is manually reset remotely by an external type RSI/RSU reset button with indicating lamp.

The lamp will light up when the overheating protection has tripped.

For 230V, a PULSER 220 R can be used which, in addition to the ordinary control functions, also has a built-in reset button and indicating lamp.

For 400V, a PULSER or TTC and an external RSI/RSU reset button are used.

- E

Suitable control by type TTC regulator.

The built-in manual overheating protection is reset on the duct heater cover. The overheating protections are single-pole and must be connected to an external operating circuit.

Rating of 12000 W.



Project design/ordering

Descriptive text for – R

VEAB type CV –R duct heater with casing of Aluzinc-coated sheet steel and stainless steel heater element to EN 1.4301. The duct heaters conform to air tightness class C to EN 1751. Control takes place by an external regulator and sensor that must be ordered separately.

Descriptive text for – E

VEAB type CV –E duct heater with casing of Aluzinc-coated sheet steel and stainless steel heater element to EN 1.4301. The duct heaters conform to air tightness class C to EN 1751. Control takes place by an external regulator and sensor that must be ordered separately.

Type designation

(example)

CV 16 - 50 - 2 R

Size designation, see page 4

Rating in watt x 100

Voltage 1=230V ~ 2=400V2~ 3=400V3~

Type of control (-E/-R; see above)

CV

Electric circular duct heater for air velocity down to 0,5 m/s

Versions

- PTU

Duct heater with built-in temperature regulator for room or duct sensor. The heater can be reset for external setpoint adjustment or for setpoint adjustment on the heater cover. For sensor/setpoint combinations for the CV, see page 7. The sensor and the setpoint adjuster are available as separate accessories, see page 16-17.

- PTEM

Duct heater with built-in control equipment for room sensor with setpoint adjuster type TG-R430 and supply air sensor TG-K360. The required room air temperature is set on the TG-R430. The minimum and maximum supply air temperatures are set on the duct heater circuit board. For sensor/setpoint combinations for the CV, see page 9. The sensor and the setpoint adjuster are available as separate accessories, see page 16-17.

- PTXL

Duct heater with built-in control equipment for 0...10V control signal. The heater has a built-in relay with potential-free alarm contacts that indicate loss of power supply or tripping of the manually resettable overheating protection.

- P

The duct heater must be equipped with an external temperature regulator and sensor. Suitable control by PULSER regulator for ratings above 230 W. Below 230 W a version with built-in control is recommended. The overheating protection is reset manually on the duct heater cover. The sensor and the setpoint adjuster are available as separate accessories, see page 16-17.

- PTUL/-PTEML / -PL

Same models as -PTU/-PTEM/-P but with built-in relay with potential-free alarm contacts that indicate loss of power supply or tripping of the manually resettable overheating protection.



Installation

The duct heaters can be installed in either a horizontal or a vertical duct. The air must flow through the duct heater in the direction of the arrow shown on the duct heater. In a horizontal duct, the junction box may face either upwards or at 90° to either side. Installation with the junction box at the bottom is not permissible. The distance to or from a duct bend, fan, damper or the like must be at least twice the connection diameter.

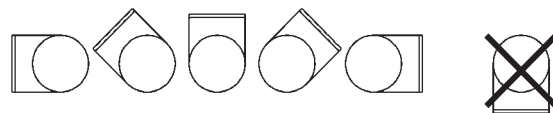

Interlock with fan/air flow rate

Electric duct heaters must always be installed so that they are interlocked either with the fan that delivers the air into the duct or with the air flow rate through the heater. The power supply to the duct heater must be isolated if the fan/air flow is switched off.

Dimensions

See page 5.

Degree of protection

CV-P... is manufactured to degree of protection IP43, but is also available to IP55 to special order (not the -PTU version).

Minimum air velocity and outlet air temperature

The duct heaters are designed for a minimum air velocity of 0.5 m/s and a maximum operating outlet air temperature of 50°C. See page 5 for calculation formula.

Power demand

See page 5 for calculation formula.

Overview of range

| Size designation | | CV 08 | CV 10 | CV 12 | CV 16 |
|---|---------|----------------|----------------|-----------------|----------------|
| Diameter (Ø mm) | | 80 | 100 | 125 | 160* |
| Minimum air flow rate m ³ /h | | 9 | 15 | 24 | 37 |
| Rating | Voltage | | | | |
| 200 W | 230V~ | X ⁵ | X ³ | X ³ | |
| 400 W | 230V~ | | X ³ | X ⁵ | |
| 600 W | 230V~ | | | X ⁷ | X ⁴ |
| 800 W | 230V~ | | | X ⁸ | |
| 1000 W | 230V~ | | | X ⁹ | |
| 1200 W | 230V~ | | | X ¹⁰ | X ⁶ |
| 1800 W | 230V~ | | | | X ⁸ |

*= Also available with Ø 150 mm dia.

3= See pressure drop curve 3, page 4

4= See pressure drop curve 4, page 4

5= See pressure drop curve 5, page 4

6= See pressure drop curve 6, page 4

7= See pressure drop curve 7, page 4

8= See pressure drop curve 8, page 4

9= See pressure drop curve 9, page 4

10= See pressure drop curve 10, page 4

Project design/ordering

Descriptive text for - PTU

VEAB type CV –PTU duct heater with casing of Aluzinc-coated sheet steel and stainless steel heater element to EN 1.4301. The duct heaters conforms to air tightness class C to EN 1751 and is designed for a min. air velocity down to 0,5 m/s. Control takes place by a built-in controller for room or duct sensor. Setpoint adjustment is carried out externally or on the heater cover. The sensor and any external setpoint adjuster must be ordered separately.

Descriptive text for - PTXL

VEAB type CV –PTXL duct heater with casing of Aluzinc-coated sheet steel and stainless steel heater element to EN 1.4301. The duct heaters conforms to air tightness class C to EN 1751 and is designed for a min. air velocity down to 0,5 m/s. Built-in relay with potential-free alarm contacts that indicate loss of power supply or tripping of the manually resettable overheating protection. Control takes place by a built-in regulator for external 0...10V control signal.

Descriptive text for - PTEM

VEAB type CV –PTEM duct heater with casing of Aluzinc-coated sheet steel and heater element of stainless steel to EN 1.4301. The duct heaters conforms to air tightness class C to EN 1751 and is designed for a min. air velocity down to 0,5 m/s. Control takes place by built-in temperature regulator for room sensor with setpoint adjuster and separate supply air sensor. The sensor and external setpoint adjuster must be ordered separately.

Descriptive text for - P

VEAB type CV –P duct heater with casing of Aluzinc-coated sheet steel and stainless steel heater element to EN 1.4301. The duct heaters conforms to air tightness class C to EN 1751 and is designed for a min. air velocity down to 0,5 m/s. Control takes place by an external regulator and sensor that must be ordered separately.

Regulators



PULSER

PULSER D

PULSER DSP

TTC 2000

TTC 40F

PULSER series

A series of electric heater regulators that control the output by time proportional control (intermittent ON/OFF control), which provides very accurate temperature control.

Degree of protection IP30 (PULSER D IP20)

Max. load 230V~, 3200 W and 400V2 ~, 6400 W (PULSER DSP 230V~ 2300 W och 400V2~ 4000 W).

PULSER

The PULSER operates with one sensor, i.e. the built-in room sensor or an external sensor, e.g. a duct sensor. Automatic switching between 230V~ and 400V2~.

PULSER D

Same characteristics as the PULSER, but for DIN rail mounting.

PULSER DSP

Same characteristics as the PULSER, but with a display and with a maximum load of 230V~ 2300 W and 400V2~ 4000 W.

PULSER M

With an additional input for minimum or maximum sensor in the supply air duct*. PULSER M then controls the room temperature, at the same time maintaining a minimum supply air temperature. Automatic switching between 230V~ and 400V2~.

*Use duct sensor/minimum sensor TG-K330.

PULSER ADD

PULSER ADD has no sensor of its own but is under slave control from another PULSER and operates in parallel with it. This means that two duct heaters can be controlled by the same sensor. Automatic resetting between 230V~ and 400V2~.

PULSER 220 R

The PULSER -R operates with one sensor, i.e. the built-in room sensor or an external sensor, e.g. a duct sensor. It is specially adapted for operating together with a CV type -R duct heater for 230V~. The PULSER -R is provided with a reset button and a lamp that lights up when the overheating protection has tripped.

TTC series

A series of electric heater regulators that control the output by time proportional control (intermittent ON/OFF control), which provides very accurate temperature control. The setpoint adjustment is set either on the TTC or on an external setpoint adjuster. The TTC series has terminals for external main sensor and min./max. sensor. Use the TG-K360 as minimum/maximum sensor. As an alternative, the TTC series can be controlled by an external 0...10V control signal.

TTC 2000

For wall mounting.

Maximum installed power: 17 kW, 400V3~

Automatic switching: 210V~ - 415V3~

Degree of protection: IP30

TTC 25 and TTC 40F

For mounting on a DIN rail in an electrical cubicle.

Automatic switching: 210V~ - 415V3~

Degree of protection: IP20

Maximum power at the terminals:

TTC 25: 25 A, 400V, 17 kW

TTC 40F: 40 A, 400V, 27 kW

PULSER 220 X010 and PULSER 380 X010

These regulators are controlled by an external 0...10V control signal. Supply voltage 230V~ and 400V2~ respectively.

Accessories

| | Product | Range | Degree of protection |
|---|---|--|----------------------|
|  | Duct sensor TG-K330 | 0-30°C | IP20 |
|  | Duct sensor TG-K360 Minimum/Maximum sensor for TTC-Series | 0-60°C | IP20 |
|  | Room sensor TG-R430 with setpoint adjustment | 0-30°C | IP30 |
|  | Room sensor TG-R530 | 0-30°C | IP30 |
|  | Room sensor TG-R630 | 0-30°C | IP54 |
|  | Pressure switch DTV200 incl. connection kit | 20 - 300 Pa Max. 5A, 230V~ | IP54 |
|  | Pressure switch AFS-222 | 10 - 3000 Pa Max. 15A, 230V~ | IP20 |
| | Connection kit | For AFS-222 | |
|  | RSI/RSU reset button | For remote resetting of overheating protection in the CV type -R | IP20 |



VEAB Heat Tech AB
Phone: +46(0)451-485 00 • Fax: +46(0)451-410 80
www.veab.com • veab@veab.com
Sweden